

CORE ONLY - drop in grille

F1

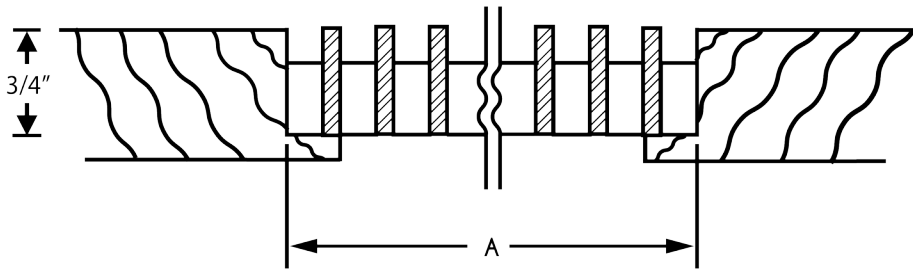

APPLICATIONS
RADIATOR
COVERS
OTHER
HORIZONTAL
SURFACES

CORE ONLY - with fastening tabs

F2

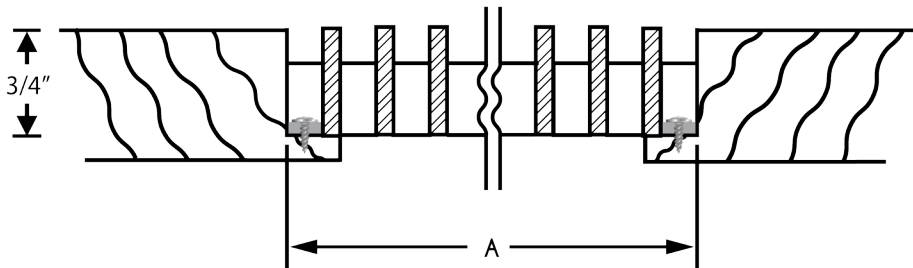

APPLICATIONS
WALL
CEILING

A FRAME - drop in grille

F3

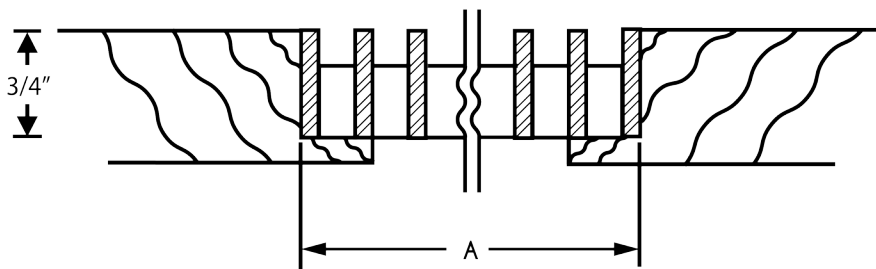

APPLICATIONS
RADIATOR
COVERS
OTHER
HORIZONTAL
SURFACES

A FRAME - with fastening tabs

F4

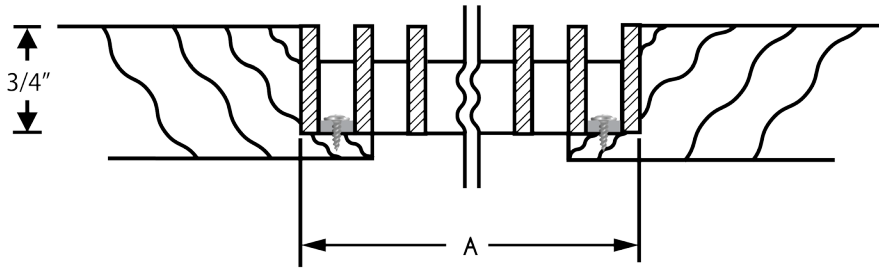

APPLICATIONS
WALL
CEILING

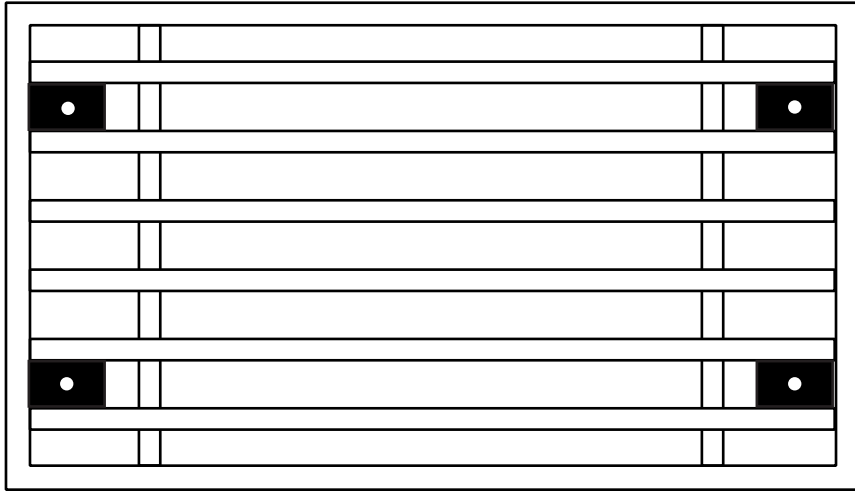

B FRAME - drop in

F5

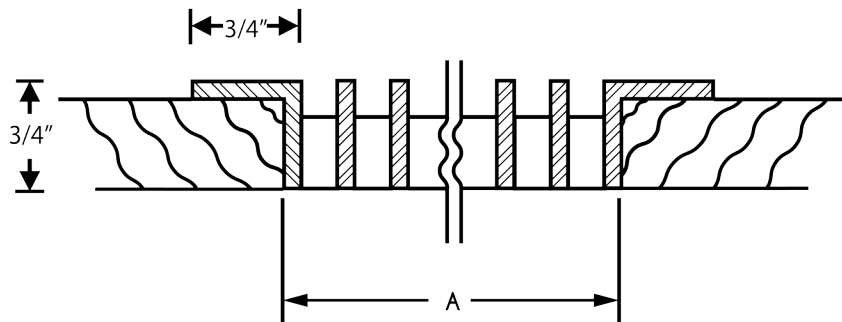

APPLICATIONS
RADIATOR
COVERS
OTHER
HORIZONTAL
SURFACES

B FRAME - fastened with screws

F6

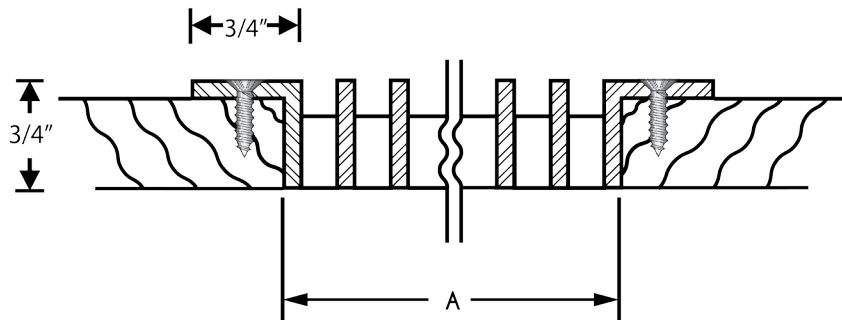

APPLICATIONS
WALL
CEILING

B FRAME - fastened with screws in prerouted block

F7

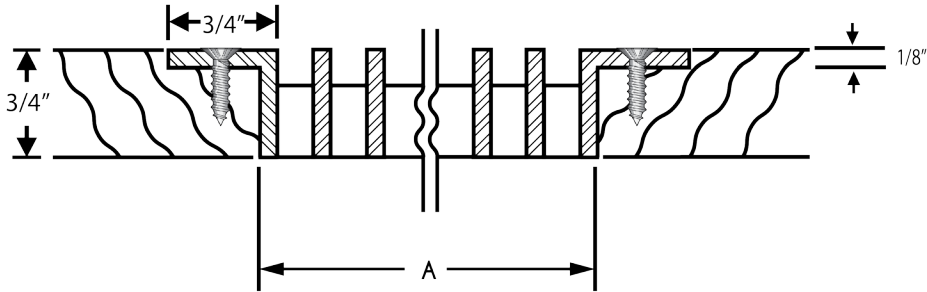

APPLICATIONS
WALL
CEILING

B FRAME - drop in prerouted block

F8

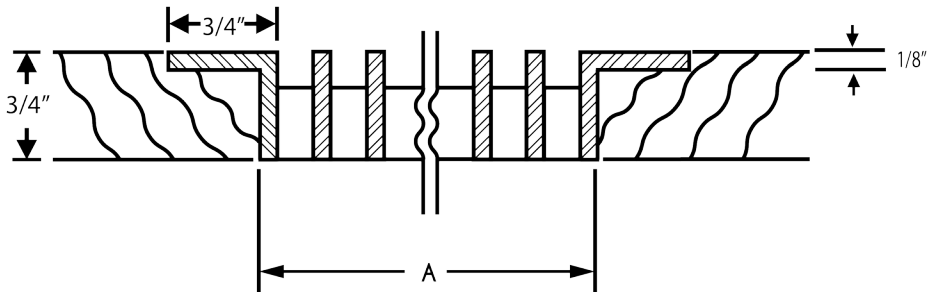

APPLICATIONS
RADIATOR
COVERS
OTHER
HORIZONTAL
SURFACES

C FRAME - REMOVABLE CORE - fastened with screws

F9

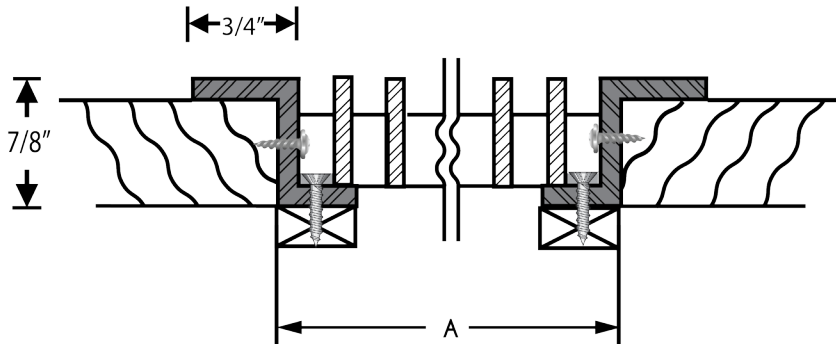

APPLICATIONS
FLOOR
WALL
CEILING
RADIATORS

C FRAME - REMOVABLE CORE - fastened with screws

F10

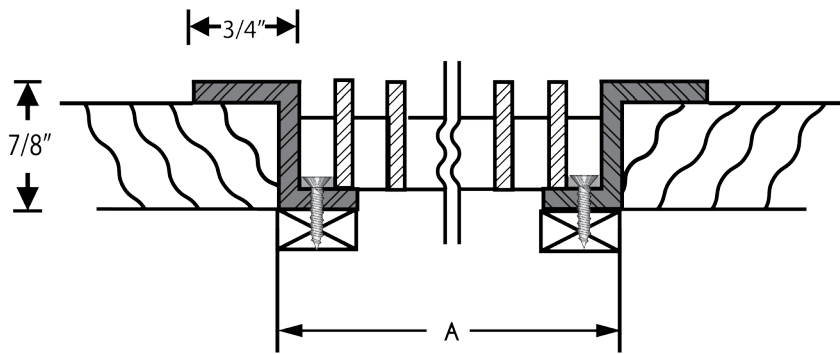

APPLICATIONS
FLOOR
RADIATOR COVERS
OTHER HORIZONTAL SURFACES

C FRAME WITH T BAR - REMOVABLE CORE

F11

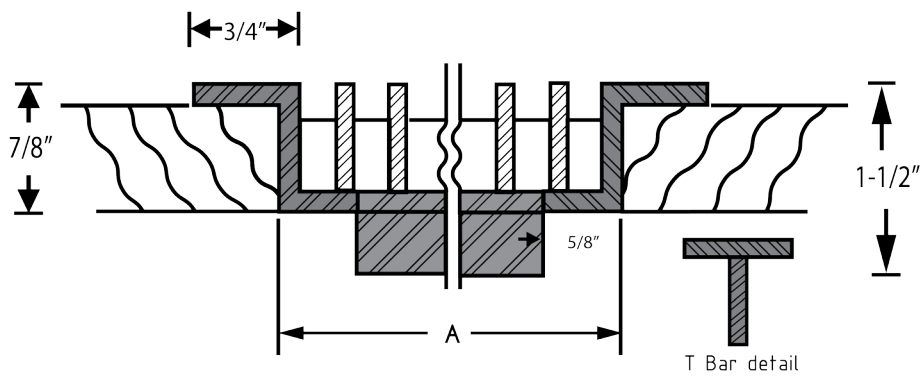

APPLICATIONS
FLOOR

C FRAME - REMOVABLE CORE - drop in

F12

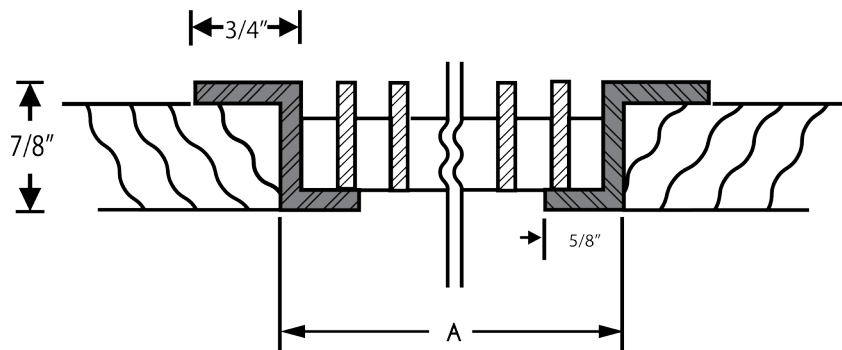

APPLICATIONS
RADIATOR COVERS

D FRAME - fastened with screws

F13

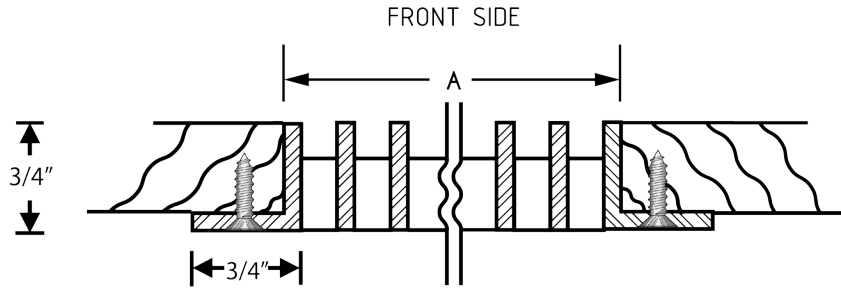

APPLICATIONS
WALL
CEILING

E FRAME - REMOVABLE CORE - drop in

F14

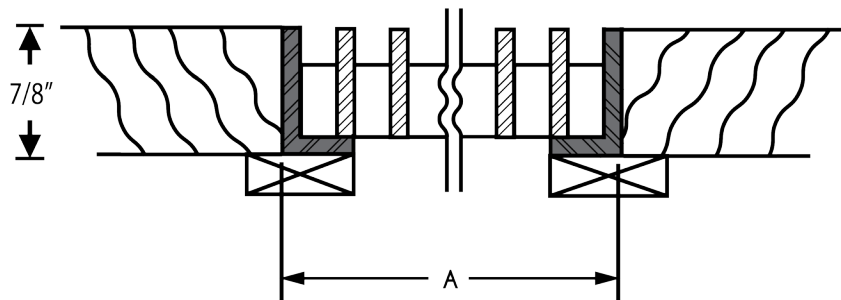

APPLICATIONS
RADIATOR
COVERS
OTHER
HORIZONTAL
SURFACES

E FRAME - REMOVABLE CORE - fastened with screws

F15

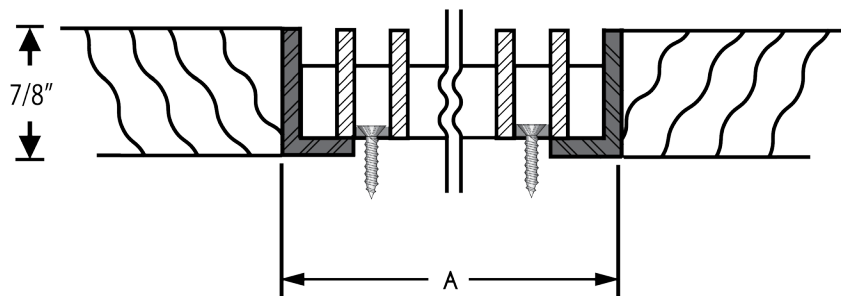

APPLICATIONS
WALL
CEILING

F FRAME - FIX CORE - CONCEALED FLANGE

F16

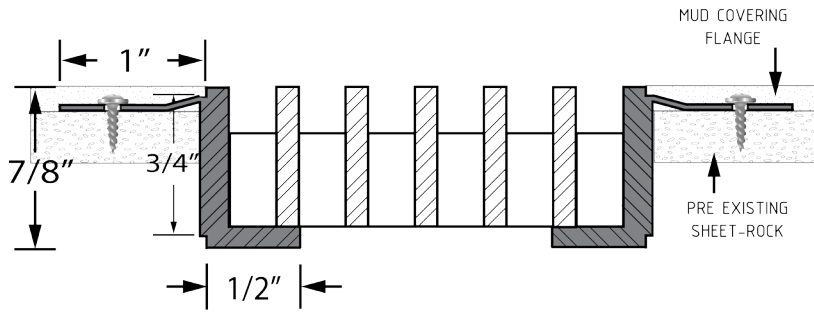

APPLICATIONS
WALL
CEILING

F FRAME - REMOVABLE CORE - CONCEALED FLANGE

F17

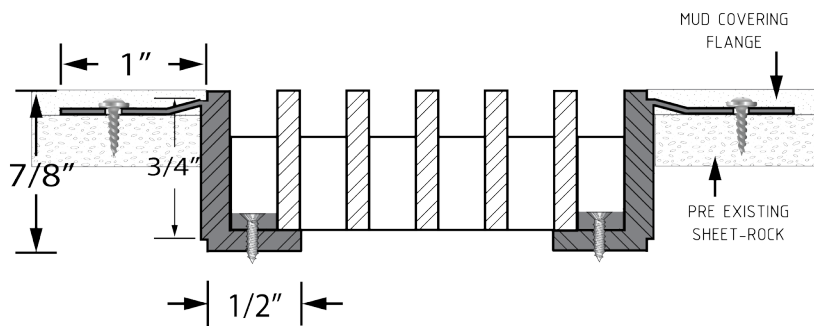

APPLICATIONS
WALL
CEILING